

HEWITT

36" Adjustable Vinyl Side Bumpers

D1BUVS

(S)

END OR SIDE
SECTION
MOUNT

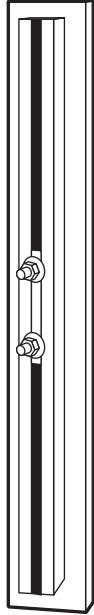

PARTS LIST – D1BUVS

- (2) 3/8" X 1-1/4" Bolt NB38114G
- (2) 3/8" Washer NW38FL
- (2) 3/8" Nut NN38S
- (2) 1/2" X 1-1/2" Carriage Bolt NB12112C
- (4) 1/2" Nut NN12S
- (1) 1/4" X 6" X 1-1/2" plate D1BUVS1
- (1) 36" Plastic Bumper D1BUPV2

D1BUVP

(P)

STAND PIPE
MOUNT

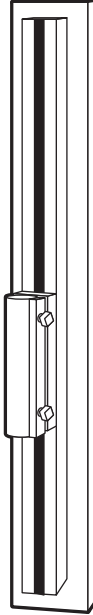

PARTS LIST – D1BUVP

- (2) 3/8" X 1-1/4" Bolt NB38114G
- (2) 3/8" Washer NW38FL
- (2) 3/8" Nut NN38S
- (2) 1/2" X 1-1/2" Set Screw LLSS
- (1) 36" Plastic Bumper D1BUPV2

D1BUVD

(D)

DECK
MOUNT

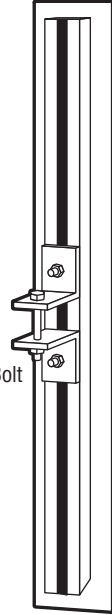

PARTS LIST – D1BUVD

- (2) 3/8" X 1" Carriage Bolt NB381C
- (2) 3/8" X 1-1/4" Bolt NB38114G
- (1) 3/8" X 5" Full Threaded Bolt NB385FT
- (2) 3/8" Washer NW38FL
- (5) 3/8" Nut NN38S
- (2) Deck Mount Angles D1BUVD1
- (1) 36" Plastic Bumper D1BUPV2

D1BUVL

(L)

LARGE
STAND PIPE
MOUNT



PARTS LIST – D1BUVL

- (2) 3/8" X 1-1/4" Bolt NB38114G
- (2) 3/8" Washer NW38FL
- (2) 3/8" Nut NN38S
- (2) 1/2" X 1-1/2" Set Screw LLSS
- (1) 36" Plastic Bumper D1BUPV2

D1BUVV

(V)

SECTIONAL
MOUNT

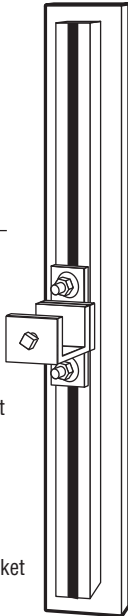

PARTS LIST – D1BUVV

- (2) 3/8" X 1-1/4" Bolt NB38114G
- (2) 3/8" Washer NW38FL
- (2) 3/8" Nut NN38S
- (2) 1/2" X 1" Carriage Bolt NB121C
- (2) 1/2" Nut NN12S
- (1) 36" Plastic Bumper D1BUPV2
- (1) Sectional Mount Bracket D1BUVV1
- (1) 1/2" X 2" Set Screw LLSS2

D1BUVA

(A)

LOCKING ARM
SQUARE MOUNT

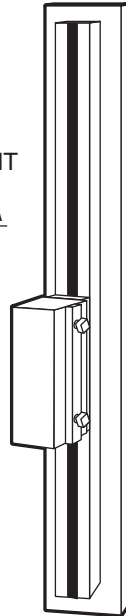

PARTS LIST – D1BUVA

- (2) 3/8" X 2" Bolt Full thread NB382FT
- (2) 3/8" Nut NN38S
- (1) 36" Plastic Bumper D1BUPV2

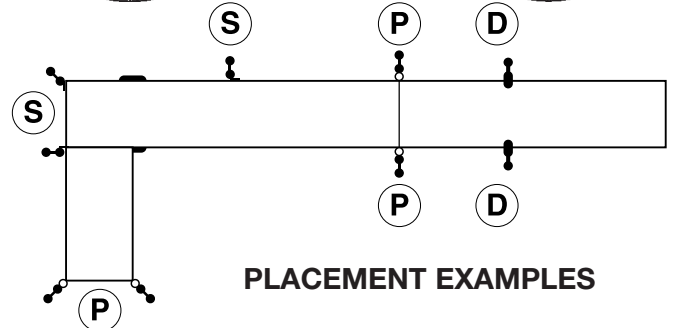
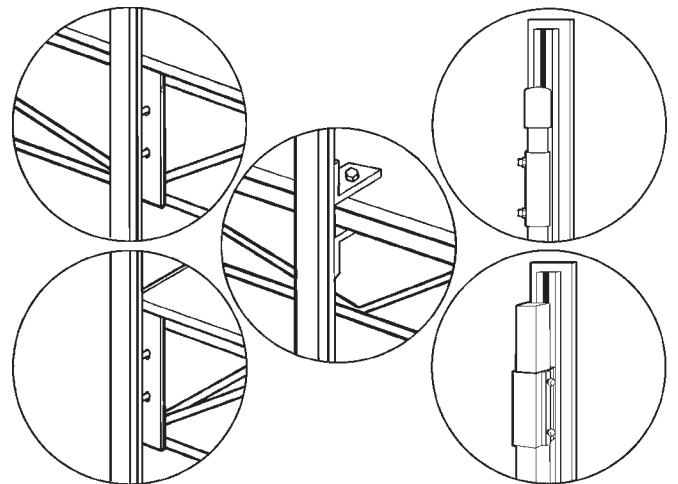

"Quality Since 1971"

HEWITT MACHINE & MFG, INC. Box 111 Nicollet, MN 56074 (507) 225-3421

www.hewitt-roll-a-dock.com e-mail: info@hewitt-roll-a-dock.com